

AS-i Safety Output Module, IP20, 1SO/3I/1EDM

Safety and standard I/O in one module

with diagnostic slave

1 release circuit; 2 x fast electronic safe outputs

1 EDM input, 2 outputs

Additional 3 standard inputs



IEC 61508 SIL 3, EN ISO 13849-1 PLe cat. 4, EN 62061 SIL 3

Protection category IP20



(Figure similar)



Figure	Type	Housing	Inputs digital, EDM ⁽¹⁾	Outputs Safety, SIL 3, cat 4	Input voltage (sensor supply) ⁽²⁾	Output voltage (actuator supply) ⁽³⁾	AS-i address ⁽⁴⁾	Article no.
	IP20, 22,5 mm x 114 mm, 4 x COMBICON, Safety	4 x COMBICON	1 EDM + 3 standard	1 release circuit; 2 x fast electronic safe outputs, max. 3 A, aug. reliability	out of AUX	out of AUX	1 single slave + 2 AB slaves	BWU3398
	IP20, 22,5 mm x 114 mm, 4 x COMBICON, Safety	4 x COMBICON	1 EDM + 3 standard	1 release circuit; 2 x fast electronic safe outputs	out of AUX	out of AUX	1 single slave + 2 AB slaves	BWU2173

(1) Inputs digital, EDM

An externally connected relay (contactor) can be connected via a feedback loop to the Safety Monitor for monitoring purposes.

(2) Input voltage (sensor supply): inputs are supplied by AS-i or by AUX (auxiliary 24 V power). If supplied by AS-i, inputs shall not be connected to earth or to external potential.

(3) Output voltage (actuator supply): outputs are supplied by AS-i or by AUX (auxiliary 24 V power). If supplied by AS-i, outputs shall not be connected to earth or to external potential

(4) AS-i address: 1 AB Slave (max. 62 AB Slaves/AS-i network), 2 AB Slaves (max. 31 modules with 2 AB Slaves), Single Slaves (max. 31 Single Slaves/AS-i network), mixed use allowed.

For modules with two slaves the second slave is turned off as long as the first slave is addressed to address "0".

Upon request, slaves are available with specific AS-i Slave profiles.

AS-i Safety Output Module, IP20, 1SO/3I/1EDM

Article no.	BWU3398		BWU2173	
Connection				
Connection	4 x COMBICON			
Length of connector cable	unlimited ⁽¹⁾			
AS-i				
Profile	Diagnostic slave: S-7.A.E., ID1=5 AB slave: S-7.A.E., ID1=7			
Address	1 single slave + 2 AB slaves			
Required Master profile	≥M3			
As of AS-i specification	2.1			
Operating voltage	30 V (18 ... 31.6 V)			
Max. current consumption	< 200 mA			
AUX				
Operating voltage	24 V (18 ... 30 V)			
Max. current consumption	6 A		1 A	
Input				
Number	1 EDM + 3 standard + 1 diagnostic			
Power supply	out of AUX			
Switching current	15 mA (T = 100 µs), continuously 4 mA at 24 V			
Power supply of attached sensors	up to +25 °C	max. 100 mA		
	at +40 °C			
	at +55 °C			
External device monitoring (EDM)	supplied out of AUX, approx. 10 mA			
Output				
Number	1 release circuit; 2 x fast electronic safe outputs, augmented reliability		1 release circuit; 2 x fast electronic safe outputs	
Max. contact load	3 A _{DC-13} at 24 V		0,5 A _{DC-13} at 24 V	
Max output current	up to +25 °C	3 A per output, ∑ (In/Out) 6 A ⁽²⁾		1 A
	at +40 °C	2,6 A per output, ∑ (In/Out) 5,3 A ⁽²⁾		
	at +55 °C	2,2 A per output, ∑ (In/Out) 4,5 A ⁽²⁾		
Test pulse	if output is on: minimum interval between 2 test pulses: 250 ms pulse width: 1 ms			
Display				
LED I1...I3 (yellow)	state of inputs I1...I3			
LED 1.Y1 (yellow)	state of EDM input 1.Y1			
LED ASI (green)	on: AS-i voltage on flashing: AS-i voltage on, but peripheral fault ⁽³⁾ or address 0 off: no AS-i voltage			
LED FAULT (red)	on: no data exchange (slave address 0 or slave offline) flashing: peripheral fault ⁽³⁾ off: slave online			
LED O1, O2 (yellow)	state of outputs O1, O2			

AS-i Safety Output Module, IP20, 1SO/3I/1EDM

Article no.	BWU3398	BWU2173
Environment		
Applied standards	IEC 61508 SIL 3 EN ISO 13849-1 PLe cat 4 EN 62061 SIL 3 EN 60529	
Operating height max.	2000 m	
Ambient temperature	-30 °C ... +55 °C ⁽⁴⁾ , no condensation permitted	
Storage temperature	-25 °C ... +85 °C	
Housing	plastic, for DIN rail mounting	
Pollution Degree	2	
Protection category	IP20	
Tolerable loading referring to humidity	according to EN 61131-2	
Maximum tolerable shock and vibration stress	according to EN 61131-2	
Insulation voltage	≥ 500 V	
Weight	150 g	
Dimensions (W / H / D) in mm	25 / 105 / 114	

(1) loop resistance ≤ 150 Ω

(2)

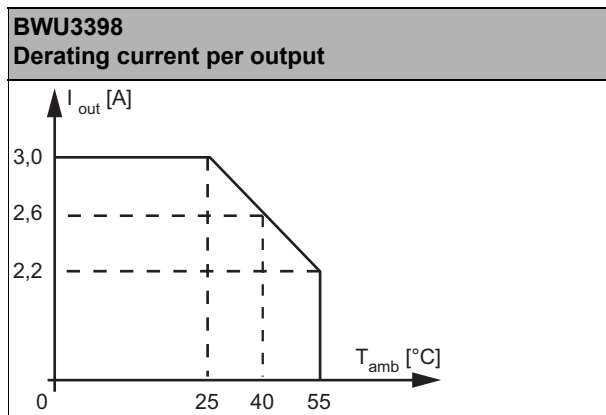

(3) see table "Peripheral fault indication"

(4) temperature range up to -30°C from Ident.No. ≥16367

Wiring rules

Push-in terminals	
General	
Nominal cross section	2,5 mm ²
Conductor cross section	
Conductor cross section solid	0,2 ... 2,5 mm ²
Conductor cross section flexible	0,2 ... 2,5 mm ²
Conductor cross section flexible, with ferrule	without plastic sleeve: 0,2 ... 2,5 mm ² with plastic sleeve: 0,25 ... 2,5 mm ²
2 conductors with same cross section, stranded, with TWIN ferrules	without plastic sleeve: 0,5 ... 1,5 mm ²
AWG	24 ... 14
Stripped insulation length	10 mm

AS-i Safety Output Module, IP20, 1ISO/3I/1EDM

Article no.	Peripheral fault indication		
	Overload sensor supply	Output short circuited	AUX voltage missing
BWU2173	•	-	•
BWU3398	•	-	•

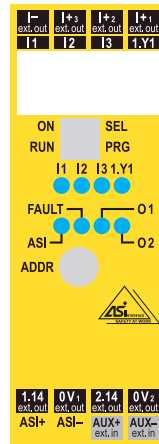
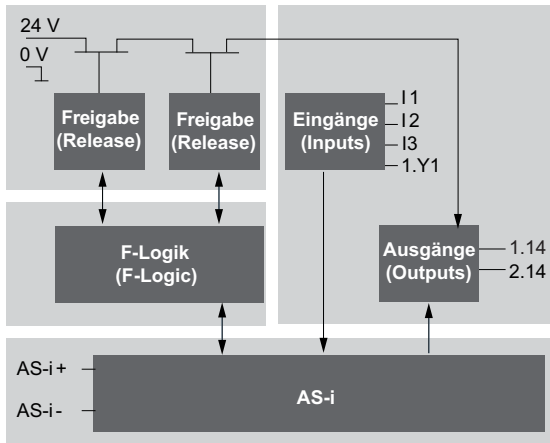

Clamps	Description
I1, I2, I3	standard inputs I1, I2 and I3
1.14	semiconductor output 1
2.14	semiconductor output 2
I-, I+	supply voltage for inputs
1.Y1	EDM 1 / input for electronic device monitoring
AS-i+, AS-i-	AS-i network connection
AUX+ _{ext.in} , AUX- _{ext.in}	voltage supply input

Programming instructions (bit values of inputs/outputs, 3I standard inputs and 1 EDM input)

Bit	AS-i output	Bit	AS-i input
O0	not used	I0	I1
O1	not used	I1	I2
O2	not used	I2	I3
O3	inexistent	I3	1.Y1

Programming instructions (bit values of the diagnostic slave)

Bit	AS-i output	Bit	AS-i input
O0	Parameter P1=1 not used Parameter P1=0 1: output O 1 controlled by safety release 0: inhibits output O 1 on irrespective of safety release	I0	diagnostic (for definition see table device colors)
O1	Parameter P1=1 not used Parameter P1=0 1: output O 2 controlled by safety release 0: inhibits output O 2 on irrespective of safety release	I1	
O2	not used	I2	
O3	inexistent	I3	Parameter P2=0 1.Y1 Parameter P2=1 1: feedback for user: <i>safety release on</i> 0: feedback for user: <i>safety release off</i>

Peripheral fault indicates unavailable 24 V ext.

AS-i Safety Output Module, IP20, 1SO/3I/1EDM







Diagnostic (device colors)

Value	Color	Description	State change	LED O1, O2
0	green	output on		on
1	green flashing	–		–
2	yellow	restart inhibit	auxiliary signal 2	1 Hz
3	yellow flashing	–		–
4	red	output off		off
5	red flashing	waiting for "reset of error condition"	auxiliary signal 1	8 Hz
6	gray	internal error, such as "fatal error"	only via "Power On" on device	all LEDs flashing
7	green/yellow	output released, but not switched on	switching-on by setting of O1	off











Programming instructions (bit values of the AS-i parameter, diagnostic slave)

Bit P1	
P1=1	safe output controlled by safety release only
P1=0	safe output controlled by output O0=1 and O1=1 in addition to safety release
Bit P2	
P2=1	feedback for user: release on AS-i bit I3
P2=0	input 1.Y1 at AS-i bit I3
Bits P0, P3:	
not used	

Release	AS-i Parameter	AS-i Safety Output Module, safety release from the AS-i safety monitor	
		... not received	... received
AS-i parameter (AB slave) changes the function of output bit O0 and O1	P1=1 (default) O0=0	semiconductor output 1 open	semiconductor output 1 closed
	P1=1 O0=1	semiconductor output 1 open	semiconductor output 1 closed
	P1=0 O0=0	semiconductor output 1 open	semiconductor output 1 open
	P1=0 O0=1	semiconductor output 1 open	semiconductor output 1 closed
	P1=1 (default) O1=0	semiconductor output 2 open	semiconductor output 2 closed
	P1=1 O1=1	semiconductor output 2 open	semiconductor output 2 closed
	P1=0 O1=0	semiconductor output 2 open	semiconductor output 2 open
	P1=0 O1=1	semiconductor output 2 open	semiconductor output 2 closed

LEDs	State	Signal / Description
ASI (green)		no operating voltage
	 1 Hz	operating voltage present, safety-related AS-i address and/or AS-i AB address is „0“ or no 24V ext. in (auxiliary power) or overload sensor supply
		operating voltage present
FAULT (red)		AS-i communication OK
		no data exchange with at least one AB slave
		no 24V ext. in (auxiliary power) or overload sensor supply

AS-i Safety Output Module, IP20, 1SO/3I/1EDM

LEDs	State	Signal / Description
O1, O2 (yellow)		semiconductor output open
	 1 Hz	restart inhibit, waiting for the start signal, the semiconductor output switches on after the start signal
	 8 Hz	device is in unlockable error state; waiting for "reset of error condition signal"; after receiving this signal the device follows up with normal operation
		semiconductor output closed
I1, I2, I3, 1.Y1 (yellow)		the corresponding input is <i>not</i> connected
		the corresponding input is connected
	 (running light)	switch is adjust to ON/PRG position
 LED on  LED flashing  LED off		

	In case all LEDs are blinking simultaneously in fast rhythm a fatal error has been detected. This message is reset by a short-run disconnection of the power supply (Power On Reset).
---	---

Accessories:

- Safe contact expander, 1 or 2 independent channels (art. no. BWU2548 / BWU2539)