

ASi Safety Output Module, IP20, 1SO/1EDM

Safety and standard I/O in one module

with ASi diagnostic node

1 release circuit; 2 x electronic safe outputs

1 EDM input, 2 outputs

IEC 61508 SIL 3, EN ISO 13849-1 PLe cat. 4, EN 62061 SIL 3

Protection category IP20



(Figure similar)



Figure	Inputs digital, EDM ⁽¹⁾	Outputs Safety, SIL 3, cat 4	Input voltage (sensor supply) ⁽²⁾	Output voltage (actuator supply) ⁽³⁾	ASi address ⁽⁴⁾	Article no.
	1 EDM	1 release circuit; 2 x electronic safe outputs, max. 3 A, aug. reliability	out of AUX	out of AUX	1 single address + 1 AB address	BWU3869

- (1) **Inputs digital, EDM:**
An externally connected relay (contactor) can be monitored by connecting the feedback loop to the EDM input.
- (2) **Input voltage (sensor supply):** inputs are supplied by ASi or by AUX (auxiliary 24 V power). If supplied by ASi, inputs shall not be connected to earth or to external potential.
- (3) **Output voltage (actuator supply):** outputs are supplied by ASi or by AUX (auxiliary 24 V power). If supplied by ASi, outputs shall not be connected to earth or to external potential.
- (4) **ASi address:** 1 AB address (max. 62 AB addresses/ASi network), 2 AB addresses (max. 31 modules with 2 AB addresses), Single addresses (max. 31 Single addresses/ASi network), mixed use allowed.
For modules with two ASi nodes the second ASi node is turned off as long as the first ASi node is addressed to address "0".
Upon request, ASi nodes are available with specific ASi address profiles.

ASi Safety Output Module, IP20, 1SO/1EDM

Article no.		BWU3869
Connection		
ASi/AUX connection	push-in terminals ⁽¹⁾	
Periphery connection	push-in terminals ⁽¹⁾	
Length of connector cable	unlimited ⁽²⁾	
ASi		
Profile	S-7.A.E, ID1=5 (default)	
Address	1 single address + 1 AB address	
Required Master profile	≥M3	
As of ASi specification	2.1	
Operating voltage	30 V (18 ... 31.6 V)	
Max. current consumption	< 200 mA	
AUX		
Operating voltage	24 V (18 ... 30 V)	
Max. current consumption	6 A	
Input		
Number	1 EDM	
Power supply	out of AUX	
Switching current	15 mA (T = 100 µs), continuously 4 mA at 24 V	
Power supply of attached sensors	up to +25 °C	max. 100 mA
	at +40 °C	
	at +55 °C	
External device monitoring (EDM)	supplied out of AUX, approx. 10 mA	
Output		
Number	1 release circuit; 2 x electronic safe outputs, augmented reliability	
Max. contact load	3 A _{DC-13} at 24 V	
Max output current	up to +25 °C	3 A per output, ∑ (In/Out) 6 A ⁽³⁾
	at +40 °C	2,6 A per output, ∑ (In/Out) 5,3 A ⁽³⁾
	at +55 °C	2,2 A per output, ∑ (In/Out) 4,5 A ⁽³⁾
Test pulse	if output is on: minimum interval between 2 test pulses: 250 ms pulse width: 1 ms	
Display		
LED 1.Y1 (yellow)	state of EDM input 1.Y1	
LED ASI (green)	on: ASi voltage on flashing: ASi voltage on, but peripheral fault ⁽⁴⁾ or address 0 off: no ASi voltage	
LED FAULT (red)	on: no data exchange (ASi address 0 or ASi node offline) flashing: peripheral fault ⁽⁴⁾ off: ASi node online	
LED O1, O2 (yellow)	state of outputs O1, O2	

ASi Safety Output Module, IP20, 1SO/1EDM

Article no.	BWU3869
Environment	
Applied standards	IEC 61508 SIL 3 EN ISO 13849-1 PLe cat 4 EN 62061 SIL 3 EN 60529
It can be used with a switched AUX cable, which is passively safe up to SIL3/PLe	no ⁽⁵⁾
Operating height max.	2000 m
Ambient temperature	-30 °C ... +55 °C ⁽⁶⁾ , no condensation permitted
Storage temperature	-25 °C ... +85 °C
Housing	plastic, for DIN rail mounting
Pollution Degree	2
Protection category	IP20
Tolerable loading referring to humidity	according to EN 61131-2
Maximum tolerable shock and vibration stress	according to EN 61131-2
Insulation voltage	≥ 500 V
Weight	150 g
Dimensions (W / H / D) in mm	22,5 / 99 / 114

(1) see table "Wiring rules"

(2) loop resistance ≤ 150 Ω

(3)

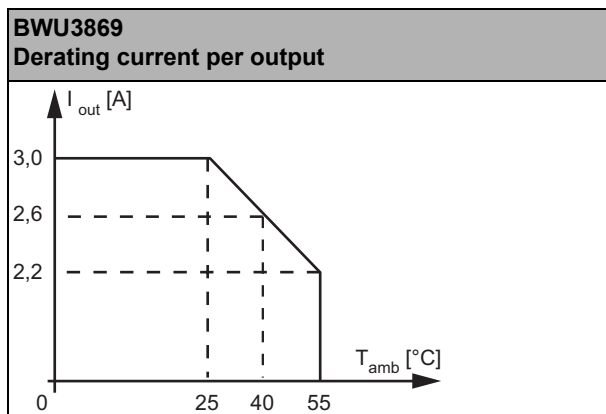

(4) see table "Peripheral fault indication"

(5) The module is not suitable for use in paths with a passively safe-switched AUX cable, since an exclusion of errors cannot be assumed for the connection of the two ASi and AUX potentials.

If the module is supplied from an unswitched AUX cable, this has no influence on the safety consideration for the paths with passively safe-switched AUX cable. In an ASi circuit, paths supplied from a passively safe-switched AUX cable and paths supplied from unswitched AUX potential can be used together.

(6) temperature range up to -30°C from Ident.No. ≥16367

ASi Safety Output Module, IP20, 1SO/1EDM

Wiring rules

Push-in terminals, 2 /3 /4 poles (pitch 5 mm)	
General	
Nominal cross section	2.5 mm ²
Conductor cross section	
Conductor cross section solid	0.2 ... 2.5 mm ²
Conductor cross section flexible	0.2 ... 2.5 mm ²
Conductor cross section flexible, with ferrule	without plastic sleeve: 0.25 ... 2.5 mm ²
	with plastic sleeve: 0.25 ... 2.5 mm ²
2 conductors with same cross section, stranded, with TWIN ferrules	without plastic sleeve: 0.5 ... 1.5 mm ²
AWG	24 ... 14
Stripped insulation length	10 mm

UL-specifications (UL508) BWU3869	
External protection	An isolated source with a secondary open circuit voltage of ≤30 V _{DC} with a 3 A maximum over current protection. Over current protection is not required when a Class 2 source is employed.
In general	UL mark does not provide UL certification for any functional safety rating or aspects of the above devices.

Article no.	Peripheral fault indication		
	Overload sensor supply	Output short circuited	AUX voltage missing
BWU3869	•	-	•

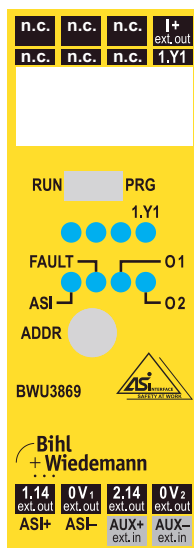
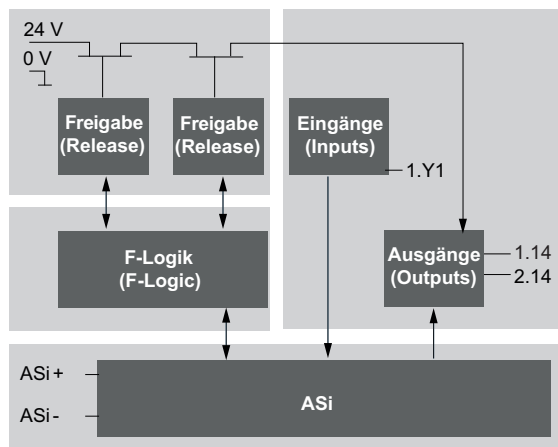

Clamps/Switch	Description
1.14	semiconductor output 1
2.14	semiconductor output 2
I+	supply voltage for inputs
1.Y1	EDM 1 / input for electronic device monitoring
ASi +, ASi -	ASi network connection
AUX +ext.in, AUX -ext.in	voltage supply input
ADDR	addressing socket
PRG	Programming of safety-related ASi address enabled.
RUN	Programming of non safety-related ASi address enabled

ASi Safety Output Module, IP20, 1SO/1EDM

Programming instructions (bit values of the ASi diagnostic node)

Bit	ASi output		Bit	ASi input	
O0	Parameter P1=1	Parameter P1=0	I0	diagnostic (for definition see table device colors)	
	not used	1: output O 1 controlled by safety release 0: inhibits output O 1 on irrespective of safety release			
O1	Parameter P1=1	Parameter P1=0	I1		
	not used	1: output O 2 controlled by safety release 0: inhibits output O 2 on irrespective of safety release			
O2	not used		I2		
O3	inexistent		I3	Parameter P2=1	Parameter P2=0
				1: feedback for user: <i>safety release on</i> 0: feedback for user: <i>safety release off</i>	1.Y1

Peripheral fault indicates unavailable 24 V ext.

Diagnostic (device colors)

















Value	Color	Description	State change	LED O1, O2
0	green	output on		on
1	green flashing	–		–
2	yellow	restart inhibit	auxiliary signal 2	1 Hz
3	yellow flashing	–		–
4	red	output off		off
5	red flashing	waiting for "reset of error condition"	auxiliary signal 1	8 Hz
6	gray	internal error, such as "fatal error"	only via "Power On" on device	all LEDs flashing
7	green/yellow	output released, but not switched on	switching-on by setting of O1	off

Programming instructions (bit values of the ASi parameter, ASi diagnostic node)

Bit P1	
P1=1	safe output controlled by safety release only
P1=0	safe output controlled by output O0=1 and O1=1 in addition to safety release
Bit P2	
P2=1	feedback for user: release on ASi bit I3
P2=0	input 1.Y1 at ASi bit I3
Bits P0, P3:	
not used	

Release	ASi Parameter	ASi Safety Output Module, safety release from the ASi safety monitor	
		... not received	... received
ASi parameter (AB node) changes the function of output bit O0 and O1	P1=1 (default) O0=0	semiconductor output 1 open	semiconductor output 1 closed
	P1=1 O0=1	semiconductor output 1 open	semiconductor output 1 closed
	P1=0 O0=0	semiconductor output 1 open	semiconductor output 1 open
	P1=0 O0=1	semiconductor output 1 open	semiconductor output 1 closed
	P1=1 (default) O1=0	semiconductor output 2 open	semiconductor output 2 closed
	P1=1 O1=1	semiconductor output 2 open	semiconductor output 2 closed
	P1=0 O1=0	semiconductor output 2 open	semiconductor output 2 open
	P1=0 O1=1	semiconductor output 2 open	semiconductor output 2 closed

ASi Safety Output Module, IP20, 1SO/1EDM

LEDs	State	Signal / Description
ASI (green)		no operating voltage
	 1 Hz	operating voltage present, safety-related ASi address and/or ASi AB address is „0“ or no 24V ext. in (auxiliary power) or overload sensor supply
		operating voltage present
FAULT (red)		ASi communication OK
		no data exchange with at least one AB node
		no 24V ext. in (auxiliary power) or overload sensor supply
O1, O2 (yellow)		semiconductor output open
	 1 Hz	restart inhibit, waiting for the start signal, the semiconductor output switches on after the start signal
	 8 Hz	device is in unlockable error state; waiting for "reset of error condition signal"; after receiving this signal the device follows up with normal operation
		semiconductor output closed
1.Y1 (yellow)		the corresponding input is <i>not</i> connected
		the corresponding input is connected
	 (running light)	switch is adjust to ON/PRG position
 LED on  LED flashing  LED off		

	In case all LEDs are blinking simultaneously in fast rhythm a fatal error has been detected. This message is reset by a short-run disconnection of the power supply (Power On Reset).
-------------------------------------------------------------------------------------	------------------------------------------------------------------------------------------------------------------------------------------------------------------------------------------

Accessories:

- Safe contact expander, 1 or 2 independent channels (art. no. BWU2548 / BWU2539)
- ASi-5/ASi-3 Address Programming Device (art. no. BW4925)
- Bihl+Wiedemann Safety Suite License - Safety Software for Configuration, Diagnostics and Commissioning (art. no. BW2916)